

Airflow Sensors

Microbridge Mass Airflow

AWM Series

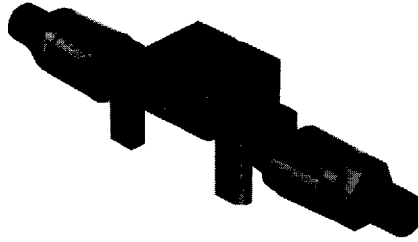
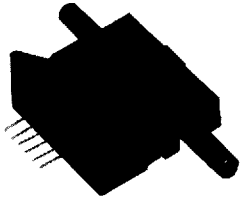

OPERATION

The microbridge mass airflow sensor operates on the theory of heat transfer due to mass airflow directed across the surface of the sensing element. Output voltage varies in proportion to the mass air or other gas flow through the inlet and outlet ports of the package.

The microbridge mass airflow sensor has a unique silicon chip based on recent advances in microstructure technology. It consists of a thin-film, thermally isolated bridge structure containing heater and temperature sensing elements. The bridge structure provides a sensitive and fast response to the flow of air or other gas over the chip. Dual sensing elements flanking a central heating element allow the indication of direction of flow as well as rate of flow. Laser trimmed thick film and thin film resistors result in consistent sensitivity from one device to the next.

A specially designed housing precisely directs and controls the airflow across the sensing microstructure. It is easily mounted to printed circuit boards.

The microbridge mass airflow sensor uses temperature-resistive films laminated within a thick film of dielectric material. These are suspended in the form of two bridges over an etched cavity in the silicon, as shown. The chip is located in a precisely dimensioned airflow channel to provide a reproducible flow response. Highly effective thermal isolation for the heater and sensing resistors is attained by the etch cavity air space beneath the flow sensor bridges. The small size and thermal isolation of the microbridge mass airflow sensor are responsible for the remarkably fast response and high sensitivity to flows.

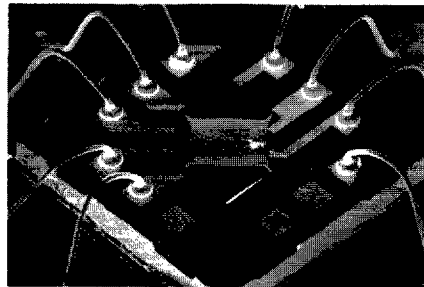

FEATURES

- State-of-the-art silicon micromachining
- Sensitive to low flows – 0.1 sccm to 20 LPM
- Adaptable for use with higher flows
- Fast response time
- Analog output
- Low power consumption
- Repeatable response
- Laser-trimmed interchangeability
- Accurate, low cost sensing
- In-line printed circuit board terminals
- Standard .100" mounting centers
- Accurate sensing of low pressure 0.001 to 2" H₂O (.003 to 5mBar)

APPLICATION

- Damper control for heating, ventilation, and air conditioning systems
- Gas analyzers
- Low vacuum control
- Process control
- Medical respirators and spirometers
- Demand oxygen supply
- Anesthesia control
- Gas metering

NOTICE

AWM Series Microbridge Mass Airflow sensors will not sense liquid flow, and may be damaged by high velocity liquid flowing through the sensor.

Airflow Sensors

Microbridge Mass Airflow

AWM 2000 Series

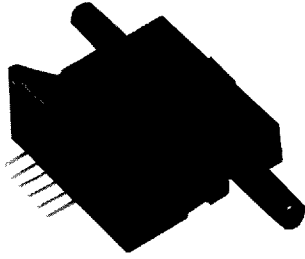

FEATURES

- Bidirectional sensing capability
- Actual mass air flow sensing

The AWM2000 series microbridge mass airflow sensor is a passive device comprised of two Wheatstone bridges: one for closed loop heater control, and one for the twin sensing elements. Figures 1 and 2 indicate the additional circuitry necessary for proper operation of the sensor.

The heater control circuit in Figure 1 is required for operation per specification. It is uniquely adapted to the flow sensor and provides an output proportional to mass flow by minimizing errors due to ambient temperature changes. The circuit is designed to keep the heater temperature at a constant differential above ambient air temperature under varying temperature and air flow. Ambient temperature is sensed by a similar heatsunk resistor on the chip.

This mode of heater operation also reduces, but does not eliminate, the effects of changes in air such as density or gas composition. These changes could alter thermal conductance and otherwise change operating characteristics of the heater and sensing resistances.

Figure 1
Heater Control Circuit

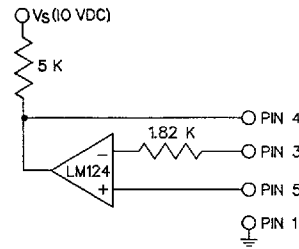
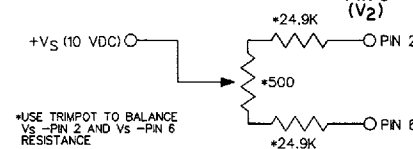

Figure 2
Sensing Bridge Supply Circuit



The sensing bridge supply circuit in Figure 2 is also required for operation per specification. This is a conventional Wheatstone bridge circuit where the dual sensing resistors make up the two active arms of the circuit. The ratiometric voltage output of the device corresponds to the differential voltage across the Wheatstone bridge circuit. As the direction of the airflow through the device is reversed, the polarity of the differential voltage goes negative, as does the voltage output of the microbridge mass airflow sensor.

The differential instrumentation amplifier in Figure 3 is a useful interface for the sensing bridge, as it can be used to increase the gain and to introduce voltage offsets to the sensor output.

Figure 3
Optional Differential Instrumentation
Amplifier Interface For Sensing Bridge

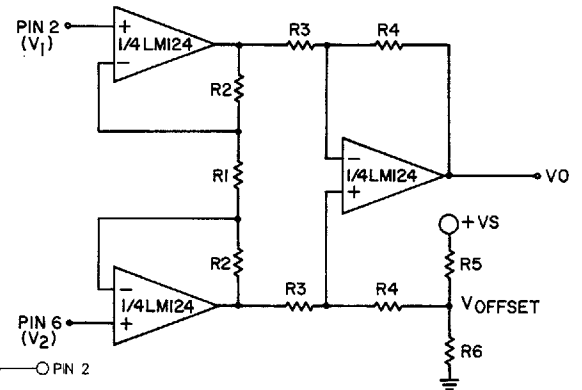

$$V_0 = \left(\frac{2R_2 + R_1}{R_1} \right) \left(\frac{R_4}{R_3} \right) (V_2 - V_1) + V_{offset}$$

$$\text{where } V_{offset} = V_S \left(\frac{R_6}{R_6 + R_5} \right)$$

Dust contamination is possible in some airflow applications, but can be minimized. Dust particles in the air stream flow past the chip parallel to its surface. In addition, the microstructure is kept clean by a thermophoretic effect, which impels micrometre-sized dust particles away from the structure. In an accelerated operating life test, with less than 50 sccm flow, a lifetime equivalent to over 20 years in a typical industrial air environment was achieved with no degradation of sensor response.

Clogging due to dust adherence to chip edges and channel surfaces can be completely prevented for low flow applications by the use of a simple filter. The optimum filtering action is obtained with the small cross-section and high flow impedance of the channel relative to a low series impedance of the filter. This permits a large accumulation of dust in the filter without significant change in the combined impedance. A disposable five-micron filter used in series upstream is adequate where filtering is desired.

Airflow

4551830 0021184 25T

Airflow Sensors

Microbridge Mass Airflow/Unamplified

AWM2000 Series

AWM2000 ORDER GUIDE

| Catalog Listings* | | AWM2100V | AWM2150V | AWM2200V | AWM2300V |
|---|--|--|--|---|--|
| ACCURACY SPECIFICATIONS at 10.0± 0.01 VDC | Flow Range (Full Scale)/ Pressure Range (psi) | ±200 sccm/ ±.2" H ₂ O (.5mBar) | ±30 SCCM/ ±.05" H ₂ O (.12mBar) | ±60 sccm (±20 sccm)/ ±2.0" H ₂ O (.5mBar) | ±1000 sccm/ ±1.3 ±.1" H ₂ O (3.2mBar) |
| | Output Voltage @ Trim Point | 30 mV @ 100 sccm | 2.5 mV @ 5 sccm | 20 mV @ 2" H ₂ O | 50 mV @ 650 sccm |
| | Null Voltage Shift, Typ. +25 to 85°C | ±0.14 mV | +±0.14 mV | ±0.05 mV | ±0.14 mV |
| | Output Voltage Shift 25 to +25°C 25 to 85°C | +2.5% Reading -2.5% Reading | +2.5% Reading -2.5% Reading | +22.0% Reading -22.0% Reading | +5% Reading (Note 4) -15% Reading (Note 4) |
| | Repeatability & Hysteresis | ±0.35% Reading max. | ±0.35% Reading | ±0.35% Reading max. | ±1% Reading Max (Note 3) |
| | | Min. | Typ. | Max. | |
| | Excitation (VDC) | 8.0 | 10±.01 | 15 (Note 2) | |
| | Power Consumption (mW) | — | — | 30 | |
| | Null Voltage (mV) | -1.0 | 0.0 | +1.0 | |
| | Response Time (msec) | — | — | 3.0 | |
| | Max. Common Mode Pressure (psi) | — | 1.0 | 25 | |
| | Sensor Resistance (Kohm) Pin 2-Pin 1, Pin 6-Pin 1 | — | 5 | — | |
| | Sensor Current (mA) Pin 2-Pin 1, Pin 6-Pin 1 Temperature Range Operating Storage | — | — | 0.6 | |
| | Termination (.100" centers) | 0.025" square | | | |
| | Weight (grams) | 10.8 | | | |
| Shock Rating (5 drops, 6 axes) | 100 g peak | | | | |

- Notes:**
1. Output Voltage is ratiometric to supply Voltage. Ratings are based on LM124 op-amp.
 2. Temperature shifts in the differential pressure devices are mostly due to the density change of the gas over temperature. Temperature shifts in the massflow devices are due to the change of the second order TCR coefficient of thin-film and thick-film resistors over temperature.

OUTPUT FLOW VS INTERCHANGEABILITY

| AWM2100V | | | AWM2150V | | | AWM2200V | | | AWM2300V | | |
|--------------|-----------|--------------|--------------|-----------|--------------|------------------------------|-----------|--------------|--------------|-----------|--------------|
| Flow sccm | NOM mV | TOL** ±mV | Flow sccm | NOM mV | TOL** ±mV | Press in H ₂ O | NOM mV | TOL** ±mV | Flow sccm | NOM mV | TOL** ±mV |
| 200 | 44.50 | 4.25 | 30 | 14 | 2.5 | 4.00 | 31.75 | 3.50 | 1000 | 55.50 | 3.70 |
| 150 | 38.75 | 3.00 | 20 | 9.5 | 1.5 | 3.00 | 26.75 | 2.50 | 800 | 52.90 | 3.5 |
| 100 | 30.00 | 1.5 | 10 | 5 | 1.5 | 2.00 | 20.00 | 1.2 | 650 | 50.00 | 2.50 |
| 50 | 16.50 | 2.50 | 5 | 2.5 | 1.0 | 1.00 | 11.20 | 1.80 | 400 | 42.50 | 3.00 |
| 0 | 0.00 | 1.0 | 4 | 2 | 1.0 | 0 | 0.00 | 1.0 | 200 | 29.20 | 3.20 |
| -50 | -16.50 | 4.50 | 3 | 1.5 | 1.0 | -1.00 | -11.20 | 3.00 | 0 | 0.00 | 1.00 |
| -100 | -30.00 | 5.00 | 2 | 1.0 | 1.0 | -2.00 | -20.00 | 3.30 | -200 | -28.90 | 15.00 |
| -150 | -38.75 | 7.65 | 1 | 0.5 | 0.8 | -3.00 | -26.75 | 5.30 | -400 | -41.20 | 26.00 |
| -200 | -44.50 | 9.75 | 0 | 0 | 0.6 | -4.00 | -31.75 | 7.00 | -600 | -48.20 | 29.50 |
| | | | | | | | | | -800 | -52.20 | 32.50 |
| | | | | | | | | | -1000 | -55.00 | 36.00 |

**The unique design of the microbridge mass airflow sensor can accommodate your special applications requirements. Custom laser-trimming and flow channel dimensioning can conform performance characteristics to specific applications. Please contact the Application Center.

Note: Do not exert a force greater than 10 lbs. on the flow ports (P₁ and P₂) in any direction.

4551830 0021185 196

OUTPUT FLOW VS INTERCHANGEABILITY - Continued

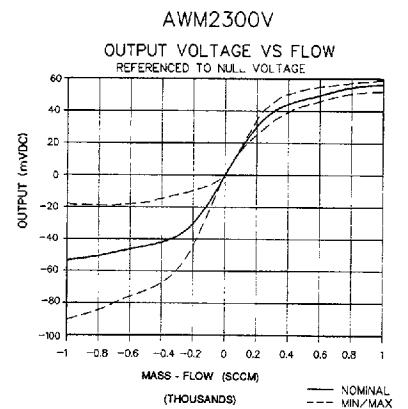
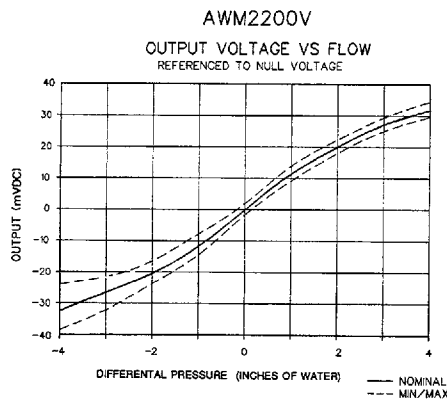
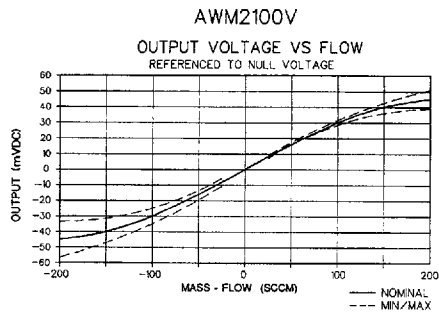

MOUNTING DIMENSIONS (For reference only)

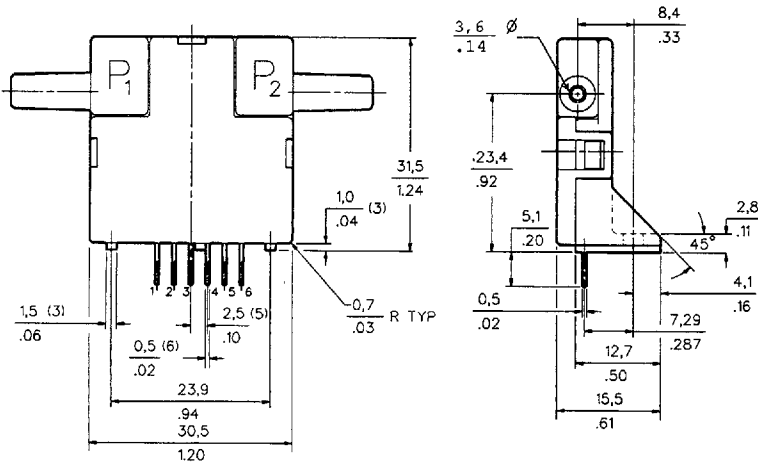
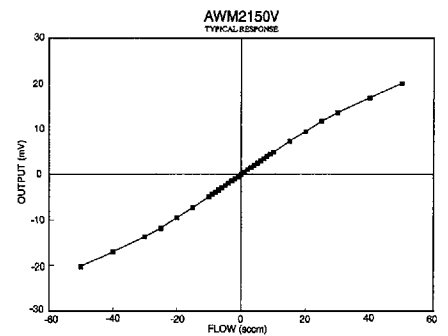
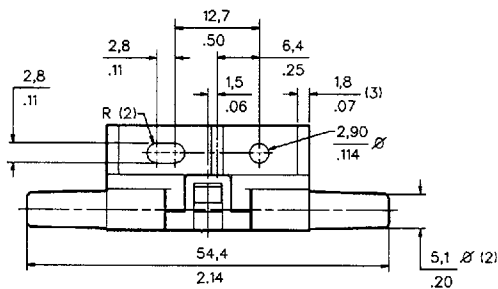

NOTE: Positive flow direction is defined as proceeding from Port 1 (P1) to Port 2 (P2) and results in positive output (PIN 6 > PIN 2). Negative flow direction is defined conversely and results in negative output (PIN 6 < PIN 2).

Airflow

Airflow Sensors

Microbridge Mass Airflow/Amplified

AWM3000 Series

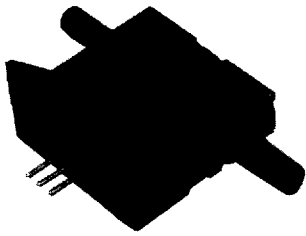

FEATURES

- Laser trimmed for interchangeability
- Flow sensing up to 1.0 LPM

Two Wheatstone bridges control airflow measurement – one provides closed loop heater control, the other contains the twin sensing elements. Figure 1 depicts the heater control circuitry. It minimizes errors due to ambient temperature changes by providing an output proportional to mass flow. The circuit keeps the heater temperature at a constant differential above ambient air temperature, despite variations in airflow and temperature.

The heater circuitry, operational amplifier, and precision thick-film resistors are located on the ceramic substrate. Ambient temperature is sensed by a similar heat-sunk resistor on the chip.

This mode of heater operation also reduces, but does not eliminate, the effects of changes in air density or gas composition. These changes could alter thermal conductance and otherwise change operating characteristics of the heater and sensing resistances.

The sensing bridge supply circuit in Figure 2 is a conventional Wheatstone bridge circuit where dual sensing resistors make up the two active arms of the circuit. The ratiometric voltage output of the device corresponds to the amplified differential voltage across the Wheatstone bridge circuit.

The supply circuit, along with the differential instrumentation amplifier shown in Figure 2 are designed into the sensor package and are precision laser adjusted during manufacture. Active laser trimming, combined with short signal paths, results in excellent noise resistance, repeatability, and sensor interchangeability.

Dust contamination is possible in some airflow applications, but can be minimized. Dust particles in the airstream flow past the chip parallel to its surface. In addition, the microstructure is kept clean by a thermophoretic effect, which impels the micrometer-sized dust particles away from the structure. In an accelerated operating life test, with less than 50 sccm flow, a lifetime equivalent to over 20 years in a typical industrial air environment was achieved with no degradation of sensor response.

Clogging due to dust adherence to chip edges and channel surfaces can be substantially eliminated through the use of a simple filter. The optimum filtering action is obtained with a low impedance filter in series with the small cross-section and high flow impedance of the channel. This permits a large accumulation of dust in the filter without significant change in the combined impedance. Where filtering is desired, a disposable five-micron filter may be used upstream of the flow sensor.

Figure 1
Heater control circuit

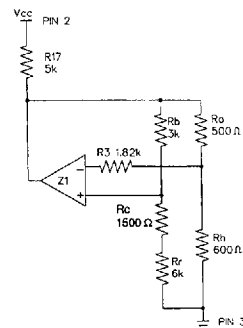
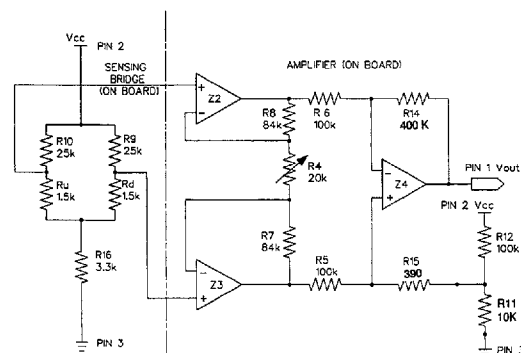

Figure 2
Sensing bridge supply circuit and differential instrumentation amplifier



4551830 0021187 T69

Airflow Sensors

Microbridge Mass Airflow/Amplified

AWM3000 Series

AWM3000 ORDER GUIDE

| Catalog Listings | | AWM3100V | AWM3150V | AWM3200V | AWM3300V |
|---|--|--|---|----------------------------------|--|
| ACCURACY SPECIFICATIONS at 10.0± 0.01 VDC | Flow Range (Full Scale)/ Pressure Range (psi) | +200 sccm/+ .2" H ₂ O (.5mBar) | 30 sccm/+1" H ₂ O (.12mBar) | +2.0" H ₂ O (5mBar) | +1000 sccm/+1.3 ±.1" H ₂ O (3.2mBar) |
| | Output Voltage @ Laser Trim Point | 5 VDC @ 200 sccm | 1.5 VDC @ 5 sccm | 5 VDC @ 2" H ₂ O | 5 VDC @ 1000 sccm |
| | Null Voltage | 1.00±.05 VDC | 1.00±.10 VDC | 1.00±.08 VDC | 1.00±.10 VDC |
| | Null Voltage Shift +25 to +85°C +25 to -25°C | ±25mV ±25 mV | ±100mV ±100 mV | ±25mV ±25 mV | ±25mV ±25 mV |
| | Output Voltage Shift 25 to -25°C 25 to 85°C | -4.0% Reading +4.0% Reading | ±5% Reading ±5% Reading | +24.0% Reading -24.0% Reading | -5.0% Reading (Note 4) +5.0% Reading (Note 4) |
| | Repeatability & Hysteresis | ±0.50% Reading max. | ±1% Reading | ±0.50% Reading max. | ±1% Reading max. |
| | | Min. | Typ. | Max. | |
| | Excitation (VDC) | 8.0 | 10±.01 | 15 (Note 2) | |
| | Power Consumption (mW) | — | 30 | 50 | |
| | Response Time (msec) | — | 1.0 | 3.0 (Note 1) | |
| | Max. Common Mode Pressure (psi) | — | — | 25 | |
| | Temperature Range Operating Storage | -25 to +85°C (-13 to +185°F) -40 to +90°C (-40 to +194°F) | | | |
| | Termination (.100" centers) | 0.025" square | | | |
| | Weight (grams) | 10.8 | | | |
| Shock Rating (5 drops, 6 axes) | 100 g peak | | | | |

Notes:

- Initial warmup time for signal conditioned circuitry is 1 minute max.
- Output Voltage is ratiometric to supply voltage.
- Repeatability and Hysteresis tolerances reflect inherent inaccuracies of the measurement equipment.
- Temperature shifts in differential pressure devices are mostly due to the density change of the gas over temperature. Temperature shifts in the massflow devices are due to the change of the second order TCR coefficient of thin-film and thick-film resistors over temperature, plus shifts in Op Amp.

OUTPUT FLOW VS. INTERCHANGEABILITY

| AWM3100V | | | AWM3150V * * | | | AWM3200V | | | AWM3300V | | |
|--------------|----------------|-----------------------------|--------------|----------------|-----------------------------|-------------------------------|----------------|-----------------------------|--------------|----------------|-----------------------------|
| Flow sccm | Nominal VDC | Tol. ⁽⁶⁾ ±VDC | Flow sccm | Nominal VDC | Tol. ⁽⁶⁾ ±VDC | Press in. H ₂ O | Nominal VDC | Tol. ⁽⁶⁾ ±VDC | Flow sccm | Nominal VDC | Tol. ⁽⁶⁾ ±VDC |
| 200 | 5.00 | 0.15 | 30 | 3.75 | .70 | 2.00 | 5.00 | 0.15 | 1000 | 5.00 | 0.15 |
| 175 | 4.80 | 0.16 | 20 | 2.90 | .45 | 1.75 | 4.59 | 0.15 | 900 | 4.90 | 0.16 |
| 150 | 4.50 | 0.17 | 10 | 1.95 | .20 | 1.50 | 4.16 | 0.16 | 800 | 4.80 | 0.17 |
| 125 | 4.17 | 0.18 | 5 | 1.50 | .10 | 1.25 | 3.70 | 0.20 | 700 | 4.66 | 0.18 |
| 100 | 3.75 | 0.19 | 4 | 1.40 | .08 | 1.00 | 3.25 | 0.22 | 600 | 4.42 | 0.19 |
| 75 | 3.27 | 0.19 | 3 | 1.30 | .08 | 0.75 | 2.65 | 0.22 | 500 | 4.18 | 0.20 |
| 50 | 2.67 | 0.17 | 2 | 1.20 | .07 | 0.50 | 2.15 | 0.19 | 400 | 3.82 | 0.21 |
| 25 | 1.90 | 0.13 | 1 | 1.10 | .06 | 0.25 | 1.55 | 0.11 | 300 | 3.41 | 0.19 |
| 0 | 1.00 | 0.05 | 0 | 1.00 | .05 | 0.00 | 1.00 | 0.08 | 200 | 2.96 | 0.17 |
| | | | | | | | | | 100 | 2.30 | 0.14 |
| | | | | | | | | | 0 | 1.00 | 0.10 |

- The unique design of the microbridge mass airflow sensor accommodates your special requirements. Custom laser-trimming and flow channel dimensioning can conform performance characteristics to specific applications.

4551830 0021188 9T5

Airflow Sensors

Microbridge Mass Airflow/Amplified

AWM3000 Series

OUTPUT CURVES

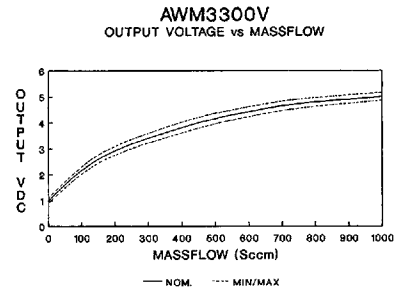
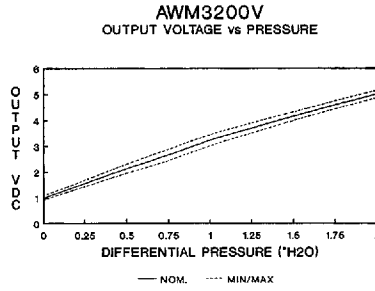
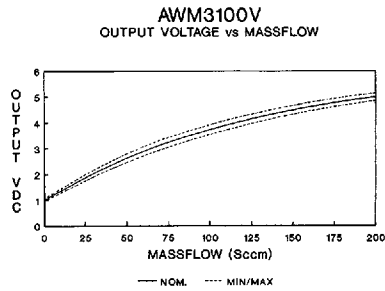

MOUNTING DIMENSIONS (For reference only)

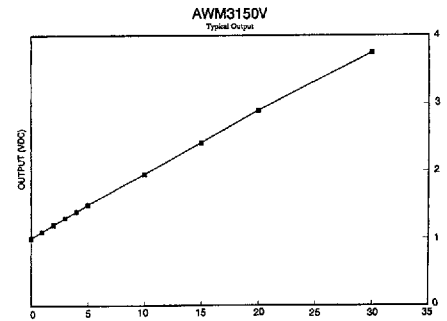
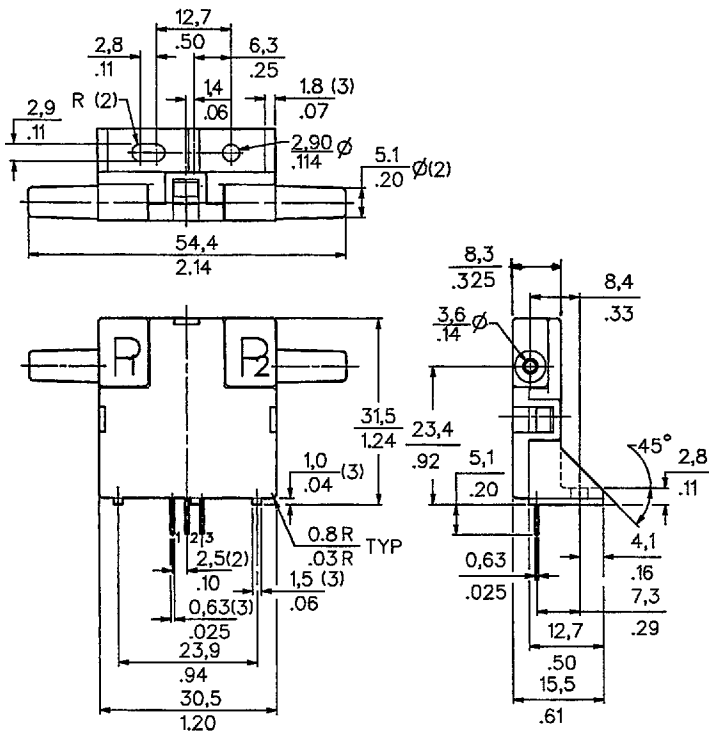

OUTPUT CONNECTIONS

| | |
|-------|------------------|
| Pin 1 | Output Voltage |
| Pin 2 | + Supply Voltage |
| Pin 3 | Ground |

NOTE: Positive flow direction is defined as proceeding into Port 1 (P1) and out of Port 2 (P2), and results in positive output.

4551830 0021189 831

Airflow Sensors

High Flow Mass Airflow/Amplified

AWM5000 Series

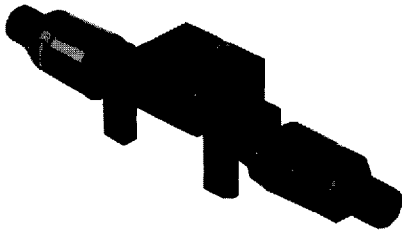

FEATURES

- Variety of flow connections possible
- Venturi design
- Remote mount
- Active laser trimmed to CO₂, N₂ or argon calibration

In-Line Flow Measurement

AWM5000 Series Microbridge Mass Airflow Sensors feature a venturi type flow housing. They measure flow as high as 20 standard liters per minute (SLPM) while inducing a maximum pressure drop of 2.25" H₂O. The microbridge chip is in direct contact with the flow stream, greatly reducing error possibilities due to orifice or bypass channel clogging.

Rugged, Versatile Package

The rugged plastic package has been designed to withstand common mode pressures up to 50 psi, and the small sensing element allows 100 g's of shock without compromising performance. The ports are separate moldings which can be modified for alternative fittings with a minimum of tooling cost or performance impact. The snap-in "AMP" compatible connector provides reliable connection in demanding applications.

On-board Signal Conditioning

Each AWM5000 sensor contains circuitry which performs amplification, linearization, temperature compensation, and gas calibration. A 1 to 5 VDC linear output is possible for all listings regardless of flow range (5, 10, 15, or 20 SLPM) or calibration gas (nitrogen, carbon dioxide, nitrous oxide, or argon). All calibration is performed by active laser trimming.

Two Wheatstone bridges control airflow measurement - one provides closed loop heater control, the other contains the twin sensing elements. Heater control circuitry is shown in Figure 1. The circuit keeps the heater temperature at a constant differential above ambient air temperature, despite variations in airflow and temperature. The heater circuitry, operational amplifier, and precision thick-film resistors are located on the ceramic substrate. Ambient temperature is sensed by a similar heatsunk resistor on the chip.

Figure 1

Heater control, sensing bridge supply circuit and differential instrumentation amplifier circuits

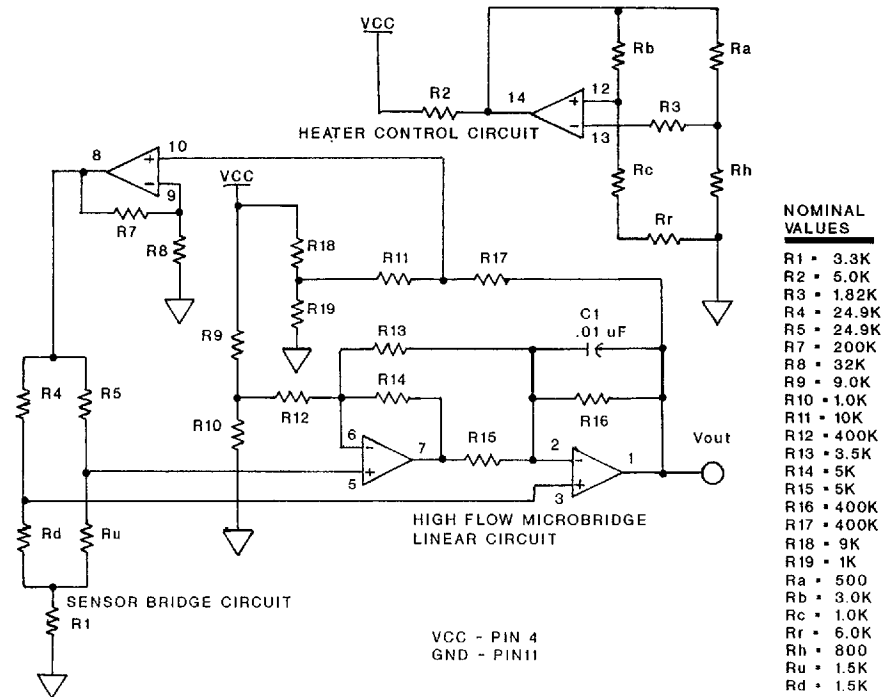

This mode of heater operation also reduces, but does not eliminate, the effects of changes in air density. These changes could alter thermal conductance and otherwise change operating characteristics of the heater and sensing resistance. See Notes.

The sensing bridge supply circuit in Figure 1 is a conventional Wheatstone bridge circuit where dual sensing resistors make up the two active arms of the circuit. The ratiometric voltage output of the device corresponds to the amplified differential voltage across this Wheatstone bridge circuit.

Circuitry in Figure 1 is designed into the sensor package and is precision laser adjusted during manufacture. Active laser trimming, combined with short signal paths, results in excellent noise resistance, repeatability, and sensor interchangeability.

Particulate contamination is a concern in some applications. Failure due to particulate impact can be substantially eliminated through the use of a simple filter. The optimum filtering action is obtained with the low impedance filter in series with the flow sensor. This permits accumulation of dust in the large diameter of a filter without significant change in the combined impedance of the system. We recommend locating a five-micron filter **upstream** of the device.

4551830 0021190 553

Airflow Sensors

High Flow Mass Airflow/Amplified

AWM5000 Series

SPECIFICATIONS

| | |
|--|--|
| Recommended power supply (1) | 10 ±.01 VDC |
| Minimum power supply | 8.0 VDC |
| Maximum power supply | 15 VDC |
| Power consumption | 100 mW max. |
| Output type | Linear, 1 to 5 VDC |
| Calibration gas | Suffix VA = Argon Suffix VC = CO ₂ , Carbon dioxide; N ₂ O, Nitrous Oxide Suffix VN = N ₂ , Nitrogen; O ₂ , Oxygen |
| Gas flow range* | AWM5101 0-5 SLM AWM5102 0-10 SLM AWM5103 0-15 SLM AWM5104 0-20 SLM |
| Output @ laser trim point | 5 VDC @ Full Scale Flow |
| Differential pressure @ full scale | See Pressure vs. Airflow Chart |
| Null output | 1.00±0.05 VDC |
| Null output shift, -20 to +70°C | ±.050 VDC typ., ±.200 VDC max. |
| Full scale output shift -20 to +25°C, +20 to 70°C | Suffix VA or VN ±7.0% Reading, VC ±10.0% Reading |
| Linearity error (2) | ±3.0% Reading |
| Repeatability & Hysteresis | ±0.5% Reading |
| Response time | 60.0 msec max. |
| Temperature range | -20 to +70°C (-4 to +158°F) |
| Termination (0.100" centers) | 0.025" square |
| Connector (4 pin receptacle)(3) | AMP (103956-3) or Micro Switch (SS12143) |
| Weight | 60 grams (2.12 oz) |
| Shock rating | 100 g peak, 6 msec half-sine (3 drops, each direction of 3 axes) |
| Maximum common mode pressure | 50 psi max. |
| Leak rate, max. | 0.1 psi/min. at static condition. See note 4 |

- Cannot guarantee calibration at supply voltages other than 10.00 ±0.01 VDC.
- Linearity specification applies from 2 to 100% full scale of gas flow range, and does not apply to null output at 0 SLM.
- Supplied in strip form. Other strip form receptacles are available, as well as various tools to assemble receptacles in strip form. Individual receptacle assemblies are also available from Amp.
- The 5000 series product has a leakage spec of less than 0.1 psi per minute at 50 psi internal pressure. If during installation, the end adapters are twisted with respect to the flowtube, this will break the seal between the o-ring and the flowtube and cause a small temporary leak. This leak might be as high as 1psi or might remain in specification. It will self-heal as the o-ring takes a new set. About 85% of the temporary leak will be gone in 24 hours. In 48 hours complete recovery will take place.

*SLM denotes standard liters per minute which is a flow measurement referenced to standard conditions of 0°C, 760 torr (sea level), 50% RH.

PRESSURE vs. AIRFLOW

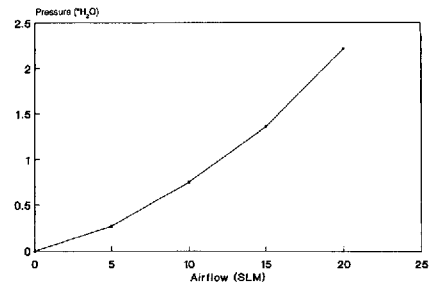

AWM5101V CHARACTERISTICS 1-5 VDC Linear Output

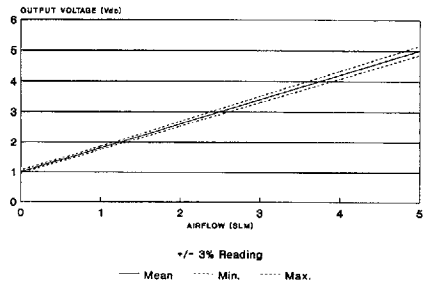

AWM5102V CHARACTERISTICS 1-5 VDC Linear Output

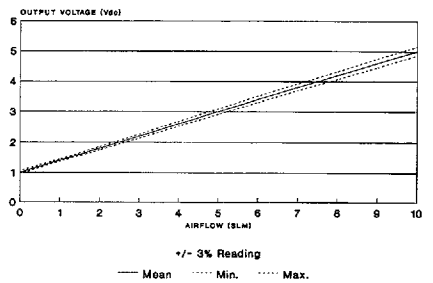

AWM5103V CHARACTERISTICS 1-5 VDC Linear Output

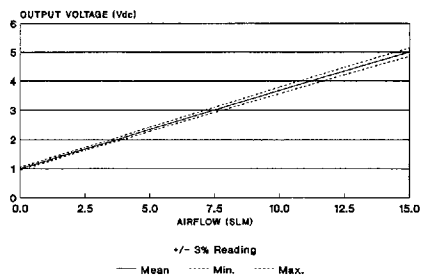

AWM5104V CHARACTERISTICS 1-5 VDC Linear Output

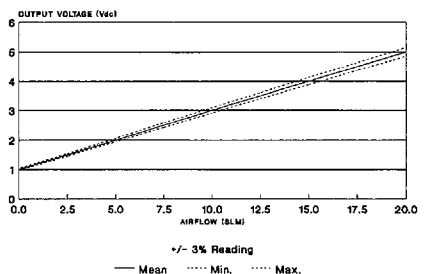

4551830 0021191 49T

Airflow Sensors

High Flow Mass Airflow/Amplified

AWM5000 Series

AWM5000 ORDER GUIDE

| Catalog Listing | Flow Range |
|-----------------|--|
| AWM5101VA | 5 SLPM, Argon calibration |
| AWM5101VC | 5 SLPM, CO ₂ calibration (2) |
| AWM5101VN | 5 SLPM, N ₂ calibration (1) |
| AWM5102VA | 10 SLPM, Argon calibration |
| AWM5102VC | 10 SLPM, CO ₂ calibration (2) |
| AWM5102VN | 10 SLPM, N ₂ calibration (1) |
| AWM5103VA | 15 SLPM, Argon calibration |
| AWM5103VC | 15 SLPM, CO ₂ calibration (2) |
| AWM5103VN | 15 SLPM, N ₂ calibration (1) |
| AWM5104VA | 20 SLPM, Argon calibration |
| AWM5104VC | 20 SLPM, CO ₂ calibration (2) |
| AWM5104VN | 20 SLPM, N ₂ calibration (1) |

CONNECTOR ORDER GUIDE

| Catalog Listing | Description |
|-----------------|--|
| SS12143 | Electrical connector (prototype quantities only) Connectors use Amp 103956-3, Molex 14-56-2042 |

NOTE: All listings have 1 - 5 VDC linear output with 10 VDC supply over given flow range for a given gas.
 1. N₂ calibration is identical to O₂ and air calibration.
 2. CO₂ calibration is identical to N₂O calibration.

OUTPUT CONNECTIONS

- Pin 1 + Supply voltage
 - Pin 2 Ground
 - Pin 3 No connection
 - Pin 4 Output voltage
- Flow direction indicated on housing

MOUNTING DIMENSIONS (for reference only)

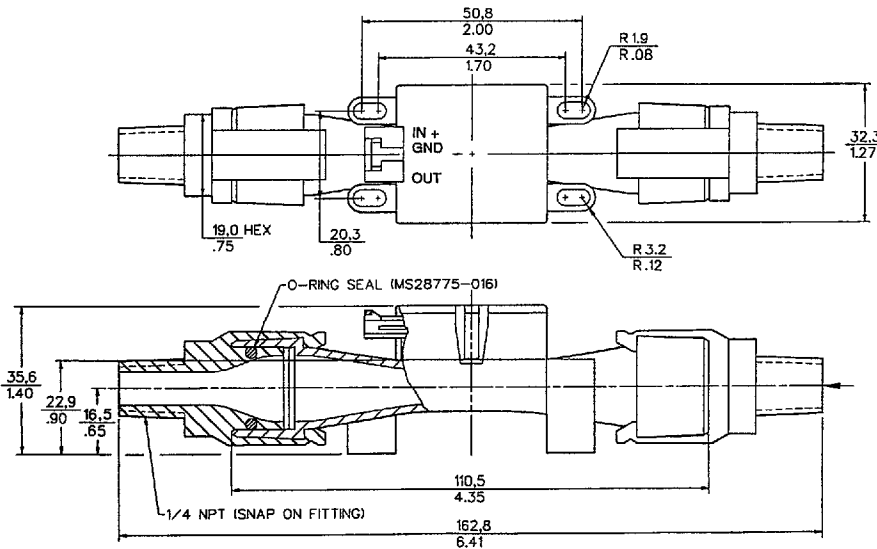

4551830 0021192 326

For application help: call 1-800-537-6945.

Honeywell • MICRO SWITCH Sensing and Control 61

Airflow